







Antares - Antro

Chair | Armchair

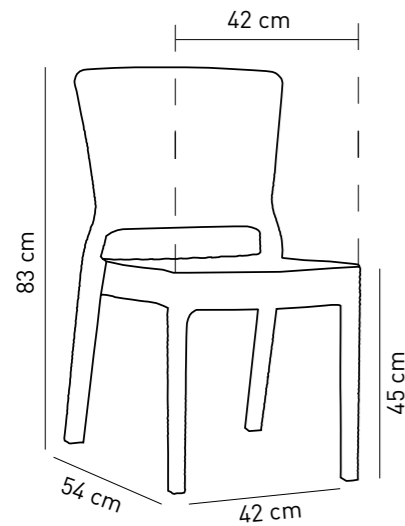
Chair Antares

It is a teammate of Armchair Antares and we believe they complete a high class set together. Chair Antares is characterized by its comfort and 'embracing' seating. The elegance of its design which is suitable for interiors and exteriors. It's a stackable chair which helps you to gain place.



	Crtn	Net : 4,00 kg	Stack	Net : 4,00 kg
		Gross : 4,95 kg		Gross : 4,38 kg
	Loading Info		Loading Info	
		20' DC : 272 pcs		20' DC : 408 pcs
		40' DC : 544 pcs		40' DC : 901 pcs
		40' HC : 636 pcs		40' HC : 1007 pcs
	Packaging Details		Packaging Details	
		4 pcs		17 pcs
		53x75x110		90x65x230h cm
		0,44 cbm		1,35 cbm
				19 pcs
				90x65x247h cm
				1,45 cbm

This product has CATAS certificate.

Ivory White
1010014001



Cream
1010014002



Coffee
1010014003



Wood
1010014007



Wenge
1010014011



Black
1010014012







Stack

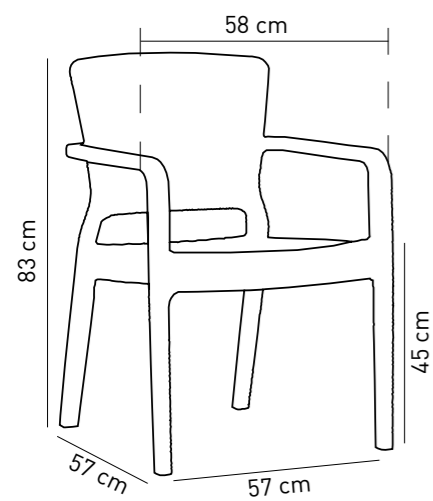

Armchair Antares

Totally rattan looking armchair is produced from 100 % virgin, glassfibre charged polypropylene and offers you ergonomic and comfortable seating. Six different colours options; Black, Wenge, Wood, Coffee, Cream and Ivory White. It's a stackable armchair which helps you to gain place. Robustness and strength has already approved by Catas.



	Crtn	Stack
	Net : 4,75 kg Gross : 5,66 kg	Net : 4,75 kg Gross : 5,12 kg
	Loading Info 20' DC : 252 pcs 40' DC : 536 pcs 40' HC : 592 pcs 90 cbm truck : 700 pcs	Loading Info 20' DC : 440 pcs 40' DC : 920 pcs 40' HC : 920 pcs 90 cbm truck : 1180 pcs
	Packaging Details 4 pcs 59x72x110 0,47 cbm	Packaging Details 17 pcs 19 pcs 95x65x230h cm 95x65x247h cm 1,42 cbm 1,50 cbm

This product has CATAS certificate.

Ivory White
1020005001



Cream
1020005002



Coffee
1020005003



Wood
1020005007



Wenge
1020005011



Black
1020005012



Stack



Cushion Options

Waterproof Fabric (Outdoor)

- Sponge thickness : 3 cm / 5 cm
- Zip
- Attaching with rope to leg

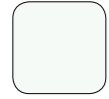

White

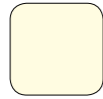

Beige



L.Brown

Chair Antares Cushion



42 cm

44 cm

Armchair Antares Cushion



49 cm

44 cm







Chair **Antares** ■
Armchair **Antares** ■

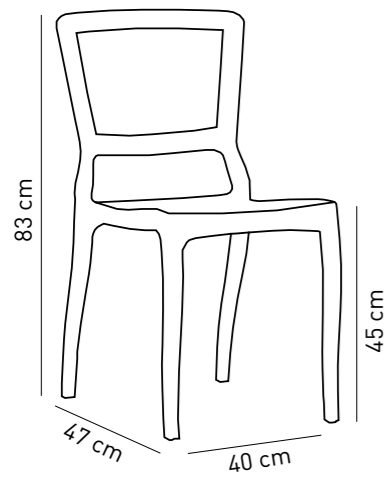

Chair Antro

It is designed to combine rattan look with modern shape in a single chair. The result is impressive. It has a completely charming view with its 's-shaped' legs. It is stackable and useful for indoor & outdoor. You can furnish your locality with its six different colors; Black, Wenge, Wood, Coffee, Cream and Ivory White.



Crtn	Stack
 Net : 3,20 kg Gross : 4,00 kg	Net : 3,20 kg Gross : 3,40 kg
 Loading Info 20' DC : 372 pcs 40' DC : 748 pcs 40' HC : 872 pcs 90 cbm truck : 1032 pcs	Loading Info 20' DC : 550 pcs 40' DC : 1166 pcs 40' HC : 1325 pcs 90 cbm truck : 1624 pcs
 Packaging Details 4 pcs 47x66x102 0,32 cbm	Packaging Details 22 pcs 25 pcs 98x65x210h cm 98x65x250h cm 1,34 cbm 1,59 cbm

Ivory White
1010015001



Cream
1010015002



Coffee
1010015003



Wood
1010015007



Wenge
1010015011



Black
1010015012



Stack



This product has CATAS certificate.

Savaş Plastik A.Ş.

Beysan Sanayi Sitesi Birlik Caddesi No:18
34524 Beylikdüzü, İstanbul, Türkiye



+90 850 346 65 65



+90 212 422 34 06



+90 212 422 46 25



www.tilia.com.tr



[/tiliafurniture](https://www.instagram.com/tiliafurniture)



[/TiliaFurniture](https://plus.google.com/+TiliaFurniture)



info@tilia.com.tr



[/tiliaContract](https://www.facebook.com/tiliaContract)



[/TiliaFurniture](https://www.pinterest.com/TiliaFurniture)



www.tilia.com.tr



Indoor 2019



Outdoor 2019