



**WEDDING**

FAMILY

Chair | Supla | Cushion



Chair Elite PC 4



Chair Elite PP 7



Chair Oxo PC 10



Chair Oxo PP 12



Chair Flora PC 4



Chair Flora PP 7



Chair Roma PC 10



Chair Roma PP 12



Chair Tiffany PC 4



Chair Tiffany PP 7



Chair Tiffany-H PP 10



Chair Napoleon PP 12



Chair Napoleon-XL PC 4



Chair Napoleon-XL PP 7



Cushion Details 10



Fabric Options 12

# Chair Elite PP

ELITE PP is an event chair and it is light, practical and stackable and can be used for both indoor & outdoor organisations. To give the ELITE PP an even precious, exclusive and sophisticated looks it is given new and surprising rustic finish.

# Elite

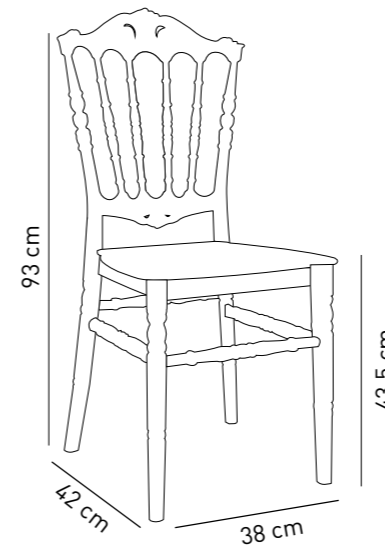

**Stack**  
Kg  
Net : 3,65 kg  
Gross : 3,85 kg

**Loading Info**  
20' DC : 468 pcs  
40' DC : 981 pcs  
40' HC : 1144 pcs  
90 cbm truck : 1430 pcs

**Packaging Details**  
9 pcs | 11 pcs  
42x62x235 | 42x62x272  
0,61 cbm | 0,71 cbm



Ivory White  
101020738



Gold  
101020741



Black  
101020743



Pearl  
101020740



Silver  
101020742



This product has CATAS certificate.



Transparent  
101020744

# Chair Elite PC

ELITE PC is an event chair and it is light, practical and stackable and can be used for both indoor & outdoor organisations. To give the ELITE PC an even precious, exclusive and sophisticated looks it is given new and surprising rustic finish.



**Stack**  
Net : 5,40 kg  
Gross : 5,65 kg



**Loading Info**  
20' DC : 424 pcs  
40' DC : 864 pcs  
40' HC : 1080 pcs  
90 cbm truck : 1300 pcs



**Packaging Details**  
8 pcs | 10 pcs  
42x62x231 | 42x62x268  
0,61 cbm | 0,71 cbm

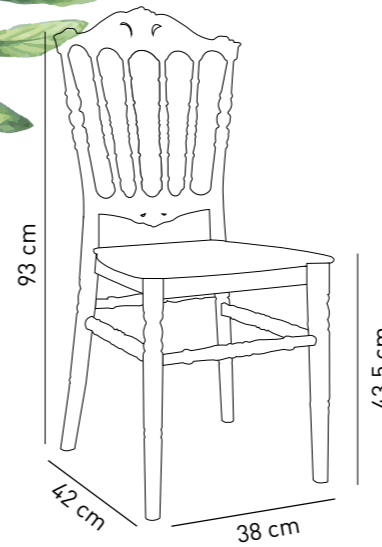

# Chair **Oxo PP**

Simply hilarious! Our OXO PP chair is our new member of our wedding range for upcoming season. OXO PP is completely a good choice for wedding halls, hotel ball rooms, pools and outdoor wedding organisations. It's round and sophisticated back makes the chair more elegant. Can be stackable up to 11 pcs and would be useful for both indoor and outdoor events.

Oxo

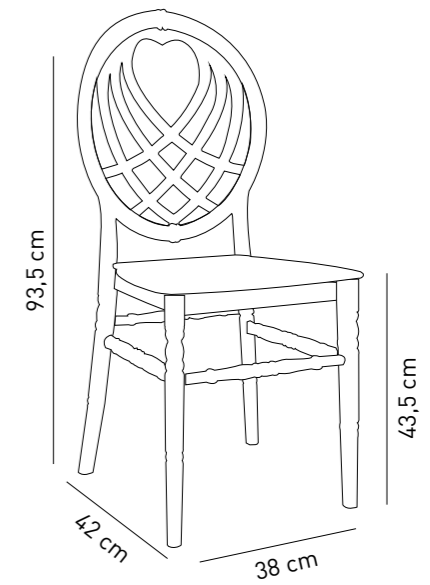

**Stack**  
Kg  
Net : 3,75 kg  
Gross : 4,07 kg

**Loading Info**  
20' DC : 468 pcs  
40' DC : 981 pcs  
40' HC : 1144 pcs  
90 cbm truck : 1430 pcs

**Packaging Details**  
9 pcs | 11 pcs  
42x62x235 | 42x62x272  
0,61 cbm | 0,71 cbm

Ivory White  
101020732



Pearl  
101020734



Gold  
101020735



Silver  
101020736



Black  
101020737



This product has CATAS certificate.





Transparent  
101020745

## Chair Oxo PC

Simply hilarious! Our OXO PC chair is our new member of our wedding range for upcoming season. OXO PC is completely a good choice for wedding halls, hotel ball rooms, pools and outdoor wedding organisations. It's round and sophisticated back makes the chair more elegant. Can be stackable up to 11 pcs and would be useful for both indoor and outdoor events.

**Stack**  
 Net : 5,30 kg  
 Gross : 5,95 kg

**Loading Info**  
 20' DC : 424 pcs  
 40' DC : 864 pcs  
 40' HC : 1080 pcs  
 90 cbm truck : 1300 pcs

**Packaging Details**  
 8 pcs | 10 pcs  
 42x62x231 | 42x62x268  
 0,61 cbm | 0,71 cbm

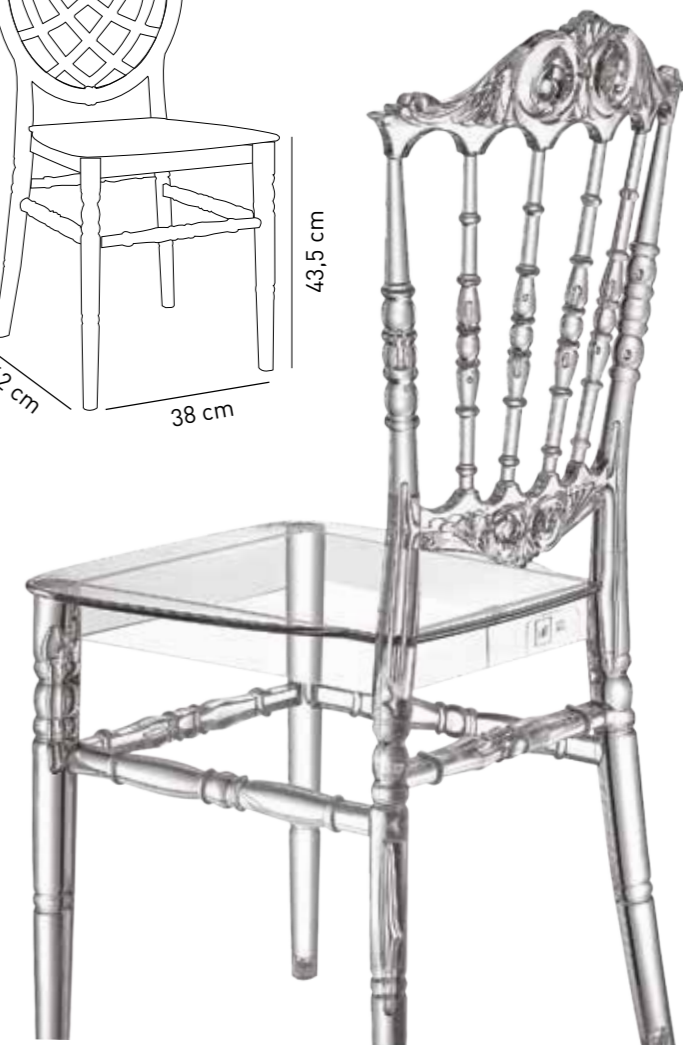
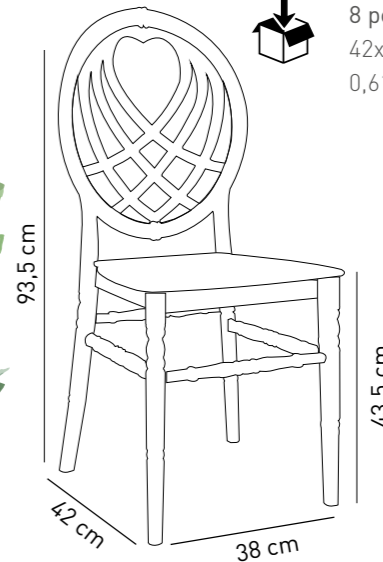

# Chair Flora PP

FLORA PP chair combines essential design with an exceptionally robust structure to produce the lightness and intangibility of its image. It is produced with gas assisted technology with 100 % virgin polypropylene, polycarbonate stackable up to 11 pcs which let you more space in your wedding halls, organisation areas or hotel ball saloon. FLORA PP is incredibly durable, flexible and suitable for both indoor and outdoor use.

*Flora*

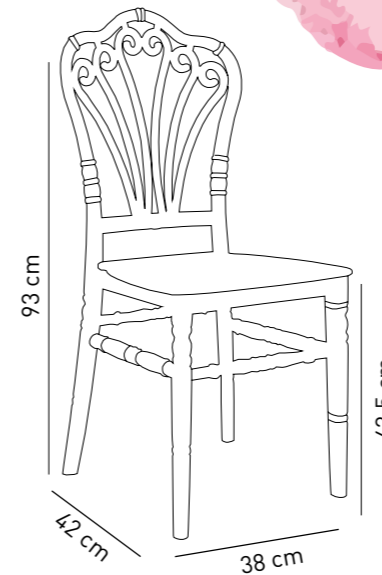

### Stack

Net : 3,85 kg  
Gross : 4,08 kg



### Loading Info

20' DC : 468 pcs  
40' DC : 981 pcs  
40' HC : 1144 pcs  
90 cbm truck : 1430 pcs



### Packaging Details

9 pcs	11 pcs
42x62x231	42x62x268
0,60 cbm	0,69 cbm



Ivory White  
101020700



Pearl  
101020725



Gold  
101020703



Silver  
101020704



Black  
101020702



This product has CATAS certificate.



Transparent  
101020705

# Chair Flora PC

FLORA PC chair combines essential design with an exceptionally robust structure to produce the lightness and intangibility of its image. It is produced with gas assisted technology with 100 % virgin polypropylene, polycarbonate stackable up to 11 pcs which let you more space in your wedding halls, organisation areas or hotel ball saloon. FLORA PC is incredibly durable, flexible and suitable for both indoor and outdoor use.

### Stack



Net : 5,50 kg  
Gross : 5,95 kg

### Loading Info



20' DC : 424 pcs  
40' DC : 864 pcs  
40' HC : 1080 pcs  
90 cbm truck : 1300 pcs

### Packaging Details



8 pcs	10 pcs
42x62x231	42x62x268
0,60 cbm	0,69 cbm

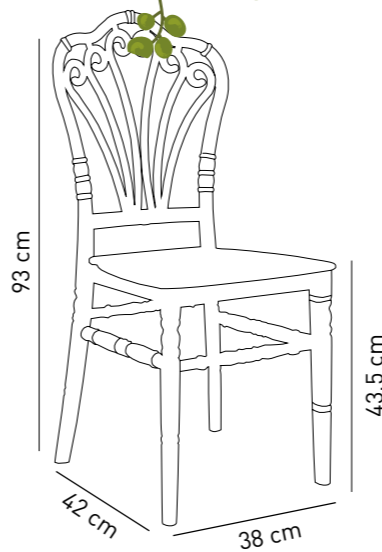



# Chair Roma PP

A most inviting chair and a baroque style back that inspires comfort, neatness. ROMA PP is the combination of sophisticated design and advanced plastic processing design. Stackable up to 11 pcs which let you more space in your wedding halls, organisation areas or hotel ball saloon. ROMA PP is incredibly durable, flexible and suitable for both indoor and outdoor use.

Roma

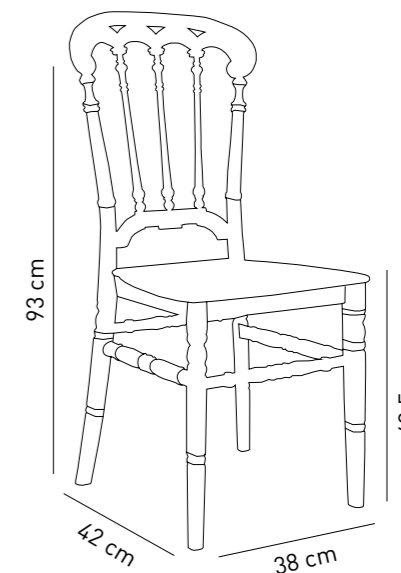

### Stack

Net : 3,90 kg  
Gross : 4,10 kg

### Loading Info

20' DC : 468 pcs  
40' DC : 981 pcs  
40' HC : 1144 pcs  
90 cbm truck : 1430 pcs

### Packaging Details

9 pcs	11 pcs
42x62x231	42x62x268
0,60 cbm	0,69 cbm

Ivory White  
101020707



Pearl  
101020711



Gold  
101020709



Silver  
101020710



Black  
101020708



This product has CATAS certificate.

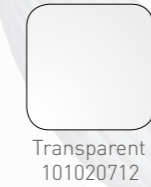

Transparent  
101020712

## Chair Roma PC

A most inviting chair and a baroque style back that inspires comfort, neatness. ROMA PC is the combination of sophisticated design and advanced plastic processing design. Stackable up to 11 pcs which let you more space in your wedding halls, organisation areas or hotel ball saloon. ROMA PC is incredibly durable, flexible and suitable for both indoor and outdoor use.

### Stack



Net : 5,40 kg  
Gross : 5,80 kg

### Loading Info



20' DC : 424 pcs  
40' DC : 864 pcs  
40' HC : 1080 pcs  
90 cbm truck : 1300 pcs

### Packaging Details



8 pcs	10 pcs
42x62x231	42x62x268
0,60 cbm	0,69 cbm

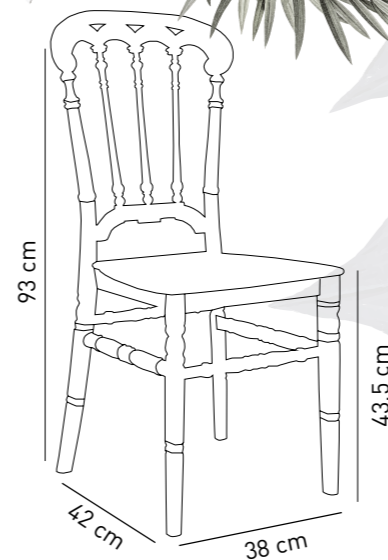

# Chair Tiffany PP

TIFFANY PP chair is made of monoblock polypropylene, polycarbonate with gas assisted injection technology. Thanks to its elegant look of the extraordinary legs and baroque style it perfectly fits into your dream wedding and organization. It can be stacked up to 11 pieces. It's both perfect for indoor and outdoor usage. It is available in ivory white, gold, silver and black colours. Cushion Uno, Cushion Due, Cushion Tre can be used with the Tiffany chair.

*Tiffany*

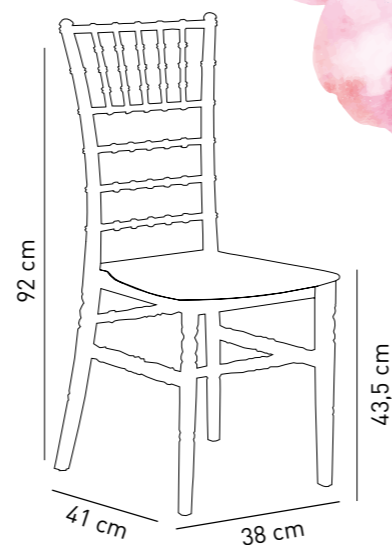

### Stack



Net : 3,90 kg  
Gross : 4,16 kg

### Loading Info



20' DC : 424 pcs  
40' DC : 864 pcs  
40' HC : 1080 pcs  
90 cbm truck : 1300 pcs

### Packaging Details



8 pcs	10 pcs
42x62x231	42x62x268
0,60 cbm	0,69 cbm



Ivory White  
101020643



Pearl  
101020350



Gold  
101020344



Silver  
101020343





Black  
101020345









# Chair Tiffany-H PP

TIFFANY-H PP chair is made of monoblock polypropylene, polycarbonate with gas assisted injection technology. Thanks to its elegant look of the extraordinary legs and baroque style it perfectly fits into your dream wedding and organization. It can be stacked up to 11 pieces. It's both perfect for indoor and outdoor usage. It is available in ivory white, gold, silver and black colours. Cushion Uno, Cushion Due, Cushion Tre can be used with the Tiffany chair.

**Stack**  
 Net : 3,75 kg  
 Gross : 4,07 kg

**Loading Info**  
 20' DC : 468 pcs  
 40' DC : 981 pcs  
 40' HC : 1144 pcs  
 90 cbm truck : 1430 pcs

**Packaging Details**  
 9 pcs      11 pcs  
 42x62x231      42x62x268  
 0,60 cbm      0,69 cbm

- Optional**
-  Ivory White  
101020726
  -  Pearl  
101020731
  -  Gold  
101020729
  -  Silver  
101020730
  -  Black  
101020728

This product has CATAS certificate.

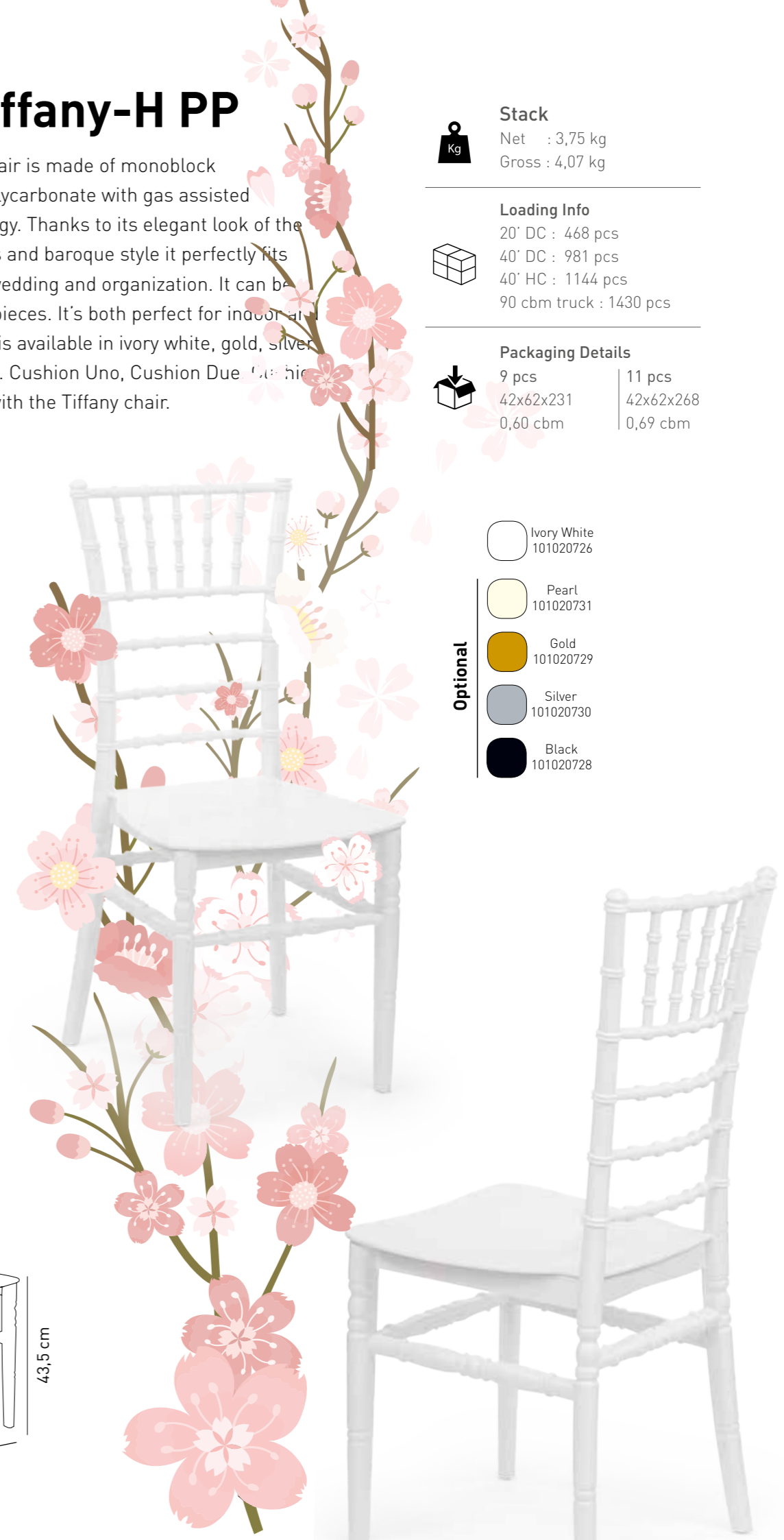
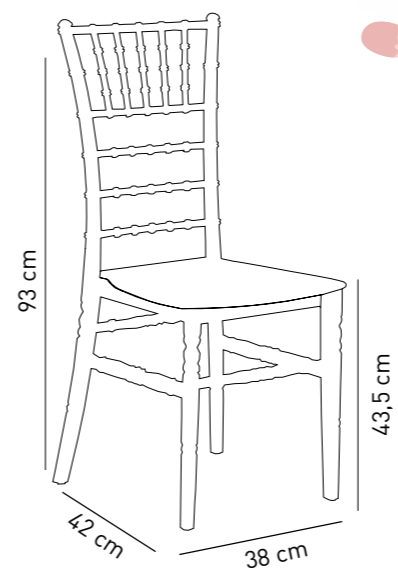



Tiffany H



# Chair Tiffany-H PC

TIFFANY-H PC chair is made of monoblock polypropylene, polycarbonate with gas assisted injection technology. Thanks to its elegant look of the extraordinary legs and baroque style it perfectly fits into your dream wedding and organization. It can be stacked up to 11 pieces. It's both perfect for indoor and outdoor usage. Cushion Uno, Cushion Due, Cushion Tre can be used with the TIFFANY-H PC chair.



Transparent  
101020720



### Stack

Net : 5,30 kg  
Gross : 5,95 kg



### Loading Info

20' DC : 424 pcs  
40' DC : 864 pcs  
40' HC : 1080 pcs  
90 cbm truck : 1300 pcs



### Packaging Details

8 pcs	10 pcs
42x62x231	42x62x268
0,60 cbm	0,69 cbm

This product has CATAS certificate.

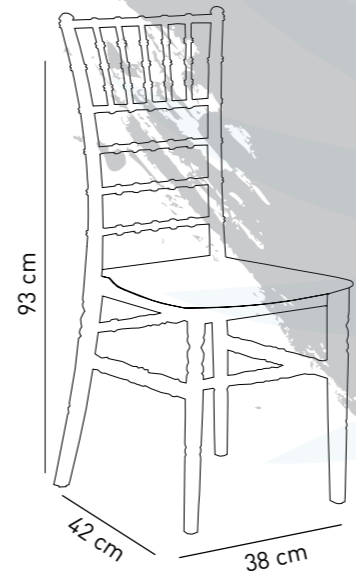

# Chair Napoleon XL PP

NAPOLEON XL PP chair is made of monoblock polypropylene and polycarbonate with gas assisted injection technology. You can furnish your space with the contemporary and fabulous NAPOLEON XL PP chair. It can be used both outdoors and indoors. Simple to stack up to 11 pieces. It is available in ivory white, gold, silver, black and transparent colours.

*Napoleon* XL

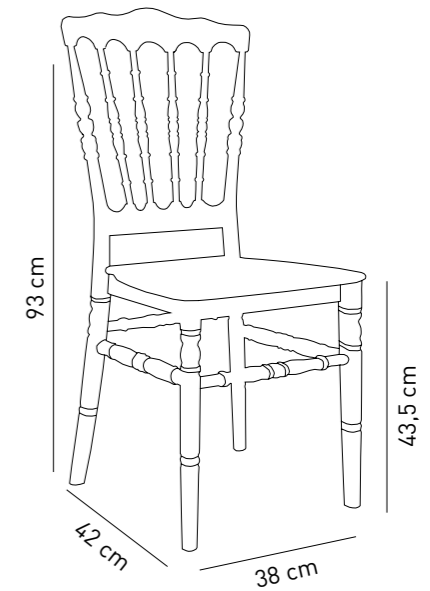

**Stack**  
 Net : 3,80 kg  
 Gross : 4,05 kg

**Loading Info**  
 20' DC : 468 pcs  
 40' DC : 981 pcs  
 40' HC : 1144 pcs  
 90 cbm truck : 1430 pcs

**Packaging Details**

9 pcs	11 pcs
42x62x231	42x62x268
0,60 cbm	0,69 cbm



Ivory White  
101020714



Pearl  
101020718



Gold  
101020716



Silver  
101020717



Black  
101020715



This product has CATAS certificate.



Transparent  
101020719

# Chair **Napoleon XL PC**

NAPOLEON XL PC chair is made of monoblock polypropylene and polycarbonate with gas assisted injection technology. You can furnish your space with the contemporary and fabulous NAPOLEON XL PC chair. It can be used both outdoors and indoors. Simple to stack up to 11 pieces.

### Stack



Net : 5,40 kg  
Gross : 5,65 kg

### Loading Info



20' DC : 424 pcs  
40' DC : 864 pcs  
40' HC : 1080 pcs  
90 cbm truck : 1300 pcs

### Packaging Details



8 pcs	10 pcs
42x62x231	42x62x268
0,60 cbm	0,69 cbm

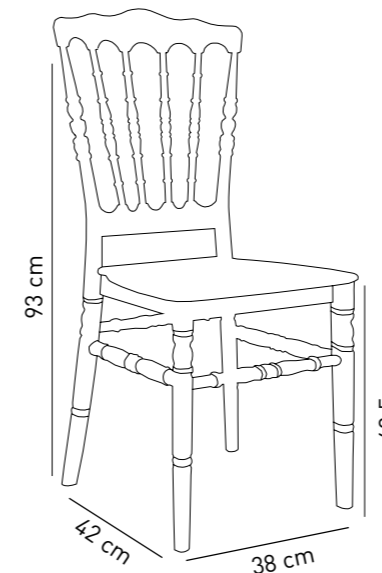

# Chair Napoleon PP

NAPOLEON PP chair is made of monoblock polypropylene with gas assisted injection technology. You can furnish your space with the contemporary and fabulous NAPOLEON PP chair. It can be used both outdoors and indoors. Simple to stack up to 10 pieces.



**Stack**  
 Net : 4,05 kg  
 Gross : 4,42 kg



**Loading Info**  
 20' DC : 424 pcs  
 40' DC : 864 pcs  
 40' HC : 1080 pcs  
 90 cbm truck : 1300 pcs



**Packaging Details**  
 8 pcs | 10 pcs  
 42x62x231 | 42x62x268  
 0,60 cbm | 0,69 cbm

Colour Options

This product has CATAS certificate.

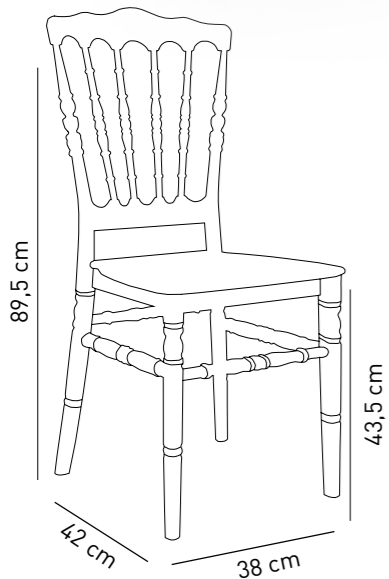

Ivory White  
101020644



Pearl  
101020352



Gold  
101020358



Silver  
101020357



Black  
101020359





## Supla **ARC**

Agnis dis dolorerum et aut abo. Nem harum re audam, unto dolut ariam que sit plautation res earupta cusdand elesto dem dolut faccusapitam que es et illat.

Suntint utem quas consequatis eicitaeria volorit atenihi ciaspel ipsanitiore volo occusae ceperum aut optatis eum sum, sam corestius, quatibus, cus

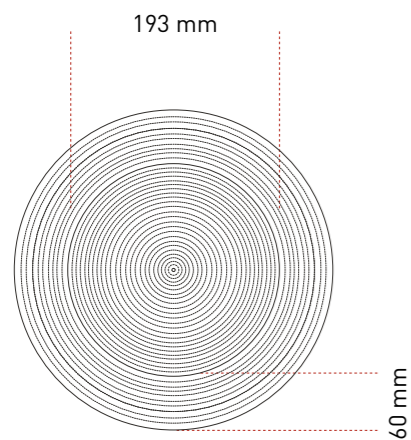

### Stack

Net : 300 gr.  
Gross : 310 gr.



### Loading Info

20' DC : 40,000 pcs  
40' DC : 80,000 pcs  
40' HC : 100,000 pcs  
90 cbm truck : 120,000 pcs



### Packaging Details

20 pcs  
33x33x14  
0,015 cbm

## Supla **Floral**

Agnis dis dolorerum et aut abo. Nem harum re audam, unto dolut ariam que sit plautation res earupta cusdand elesto dem dolut faccusapitam que es et illat.

Suntint utem quas consequatis eicitaeria volorit atenihi ciaspel ipsanitiore volo occusae ceperum aut optatis eum sum, sam corestius, quatibus, cus

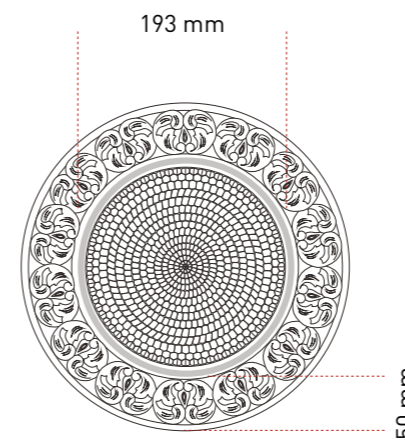

### Stack

Net : 200 gr.  
Gross : 210 gr.



### Loading Info

20' DC : 40,000 pcs  
40' DC : 80,000 pcs  
40' HC : 100,000 pcs  
90 cbm truck : 120,000 pcs



### Packaging Details

17 pcs  
33x33x14  
0,015 cbm

## Cushion UNO



- Plastic shell
- Fusing
- 3 cm 28-HD grey sponge
- Mounted to seat with velcro strip
- Fabric Options: Water repellent, artificial leather, velvet and akron



## Cushion DUE

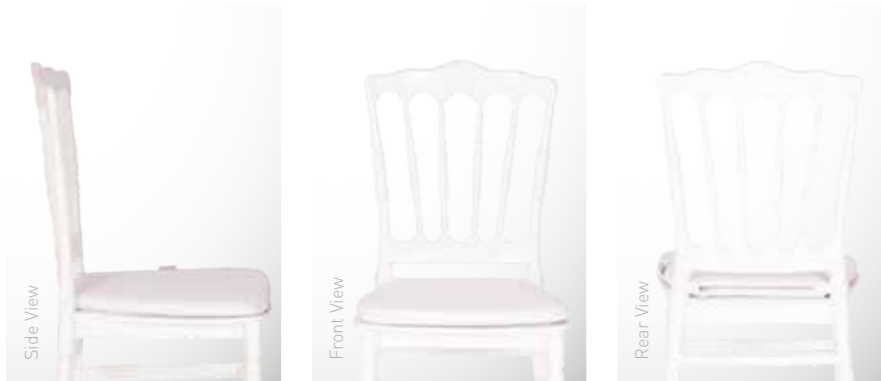

- 3 cm 28-HD grey sponge
- Zipper
- Mounted to back with velcro strip
- Fabric Options : Water repellent, artificial leather, velvet and akron



## Cushion TRE



- 3 cm 28-HD grey sponge
- Zipper
- Mounted to back with ropes
- Fabric Options : Water repellent, artificial leather, velvet and akron



## FABRIC OPTIONS

### Water repellent fabric colours

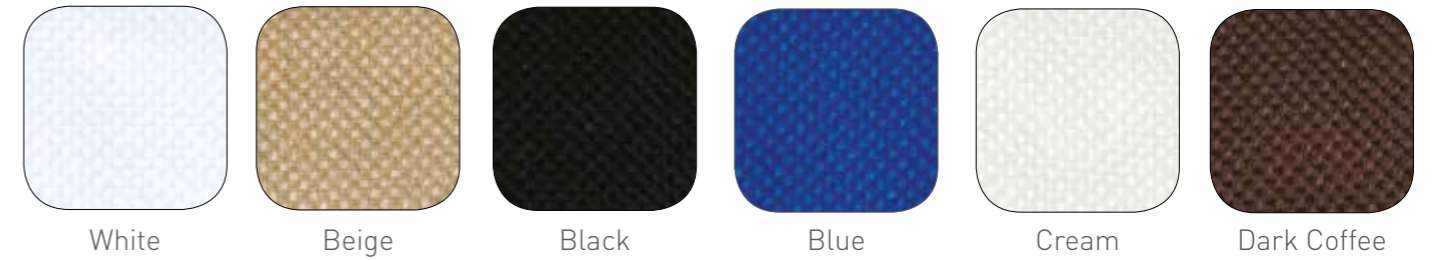

### Artificial leather fabric colours

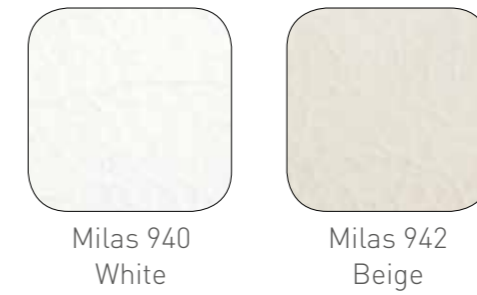

### Velvet fabric colours



### Akron fabric colours

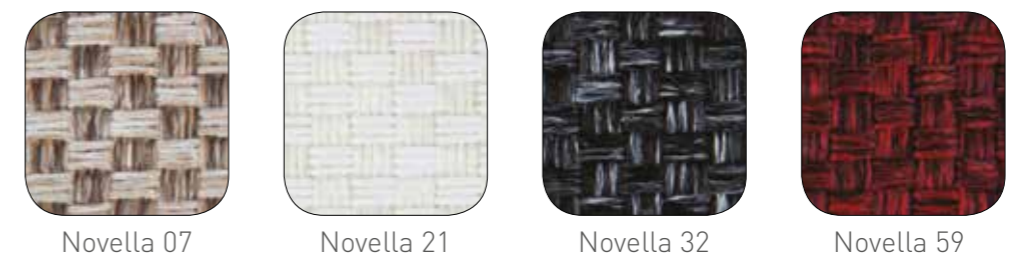

Savaş Plastik A.Ş.

Beysan Sanayi Sitesi Birlik Caddesi No:18  
34524 Beylikdüzü, İstanbul, Türkiye



+90 850 346 65 65



+90 212 422 34 06



+90 212 422 46 25



[www.tilia.com.tr](http://www.tilia.com.tr)



[/tiliafurniture](https://www.instagram.com/tiliafurniture)



[/TiliaFurniture](https://plus.google.com/+TiliaFurniture)



[info@tilia.com.tr](mailto:info@tilia.com.tr)



[/tiliaContract](https://www.facebook.com/tiliaContract)



[/TiliaFurniture](https://www.pinterest.com/TiliaFurniture)



[www.tilia.com.tr](http://www.tilia.com.tr)



Indoor 2019



Outdoor 2019