

Tilia

Wedding Range

Chair Flora PP



Flora chair combines essential design with an exceptionally robust structure to produce the lightness and intangibility of its image. It is produced with gas assisted technology with 100 % virgin polypropylene. Stackable up to 11 pcs which let you more space in your wedding halls, organisation areas or hotel ball saloon. Flora is incredibly durable, flexible and suitable for both indoor and outdoor use.

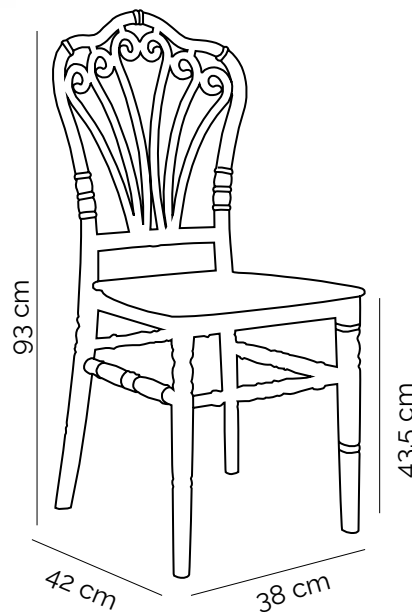

White

Net : 3,80 kg
Gross : 4,30 kg



200 kg max payload

20' DC : 450 pcs
40' DC : 927 pcs
40' HC : 1133 pcs
90 cbm Truck : 1342 pcs

Black & Gold & Silver

Net : 3,50 kg
Gross : 4,00 kg



200 kg max payload

20' DC : 450 pcs
40' DC : 927 pcs
40' HC : 1133 pcs
90 cbm Truck : 1342 pcs

9 pcs - 41X61X235 cm - 0,58 cbm / 20'DC
11 pcs - 41X61X272 cm - 0,68 cbm / 40'HC
11 pcs - 41X61X272 cm - 0,68 cbm / Truck



9 pcs - 41X61X235 cm - 0,58 cbm / 20'DC
11 pcs - 41X61X272 cm - 0,68 cbm / 40'HC
11 pcs - 41X61X272 cm - 0,68 cbm / Truck



Ivory White
101020700



Silver
101020704



Gold
101020703



Black
101020702

Chair Flora PC



Flora chair combines essential design with an exceptionally robust structure to produce the lightness and intangibility of its image. It is produced with gas assisted technology with 100 % polycarbonate. Stackable up to 11 pcs which let you more space in your wedding halls, organisation areas or hotel ball saloon. Flora is incredibly durable, flexible and suitable for both indoor and outdoor use.

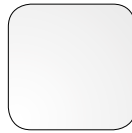

Transparent
101020705

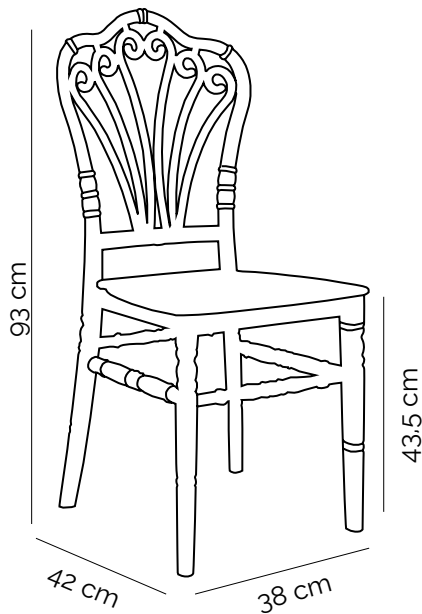

Net : 4,80 kg
Gross : 5,30 kg



200 kg max payload



20' DC : 450 pcs
40' DC : 927 pcs
40' HC : 1133 pcs
90 cbm Truck : 1342 pcs



9 pcs - 41X61X235 cm - 0,58 cbm / 20'DC
11 pcs - 41X61X272 cm - 0,68 cbm / 40'HC
11 pcs - 41X61X272 cm - 0,68 cbm / Truck



Chair Roma PP



A most inviting chair and a baroque style back that inspires comfort, neatness. ROMA is the combination of sophisticated design and advanced plastic processing design. Stackable up to 11 pcs which let you more space in your wedding halls, organisation areas or hotel ball saloon. Roma is incredibly durable, flexible and suitable for both indoor and outdoor use.

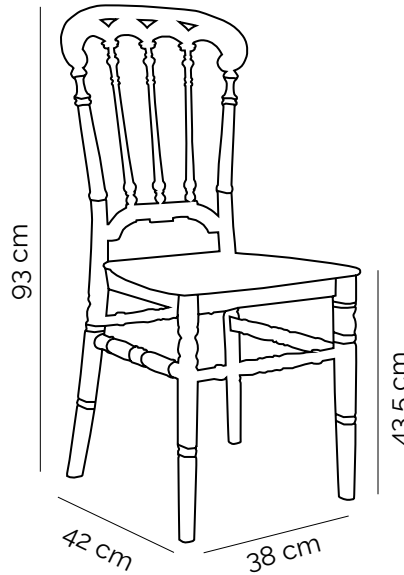

White

Net : 3,80 kg
Gross : 4,30 kg



Black & Gold & Silver

Net : 3,50 kg
Gross : 4,00 kg

200 kg max payload



200 kg max payload

20' DC : 450 pcs
40' DC : 927 pcs
40' HC : 1133 pcs
90 cbm Truck : 1342 pcs



20' DC : 450 pcs
40' DC : 927 pcs
40' HC : 1133 pcs
90 cbm Truck : 1342 pcs

9 pcs - 41X61X235 cm - 0,58 cbm / 20'DC
11 pcs - 41X61X272 cm - 0,68 cbm / 40'HC
11 pcs - 41X61X272 cm - 0,68 cbm / Truck



9 pcs - 41X61X235 cm - 0,58 cbm / 20'DC
11 pcs - 41X61X272 cm - 0,68 cbm / 40'HC
11 pcs - 41X61X272 cm - 0,68 cbm / Truck



Ivory White
101020707



Silver
101020710



Gold
101020709



Black
101020708

Chair Roma PC



The Roma chair, made of transparent polycarbonate, is the fruit of a rental idea transformed into a graceful ergonomic form. The baroque effect covering the entire structure gives this chair a light and serious look. Stackable up to 11 pcs which let you more space in your wedding halls, organisation areas or hotel ball saloon. Roma is incredibly durable, flexible and suitable for both indoor and outdoor use.

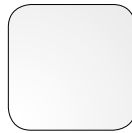

Transparent
101020712

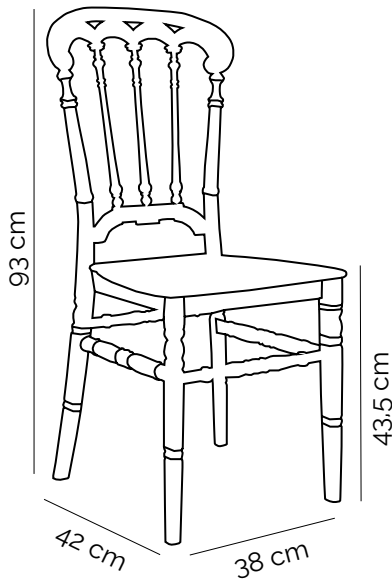

Net : 5,15 kg
Gross : 5,65 kg



200 kg max payload



20' DC : 450 pcs
40' DC : 927 pcs
40' HC : 1133 pcs
90 cbm Truck : 1342 pcs



9 pcs - 41X61X235 cm - 0,58 cbm / 20'DC
11 pcs - 41X61X272 cm - 0,68 cbm / 40'HC
11 pcs - 41X61X272 cm - 0,68 cbm / Truck



Chair Tiffany PP



Tiffany chair is made of monoblock polypropylene with gas assisted injection technology. Thanks to its elegant look of the extraordinary legs and baroque style it perfectly fits into your dream wedding and organization. It can be stacked up to 11 pieces. It's both perfect for indoor and outdoor usage. It is available in ivory white , gold, silver and black colours. Cushion Uno, Cushion Due, Cushion Tre can be used with the Tiffany chair.

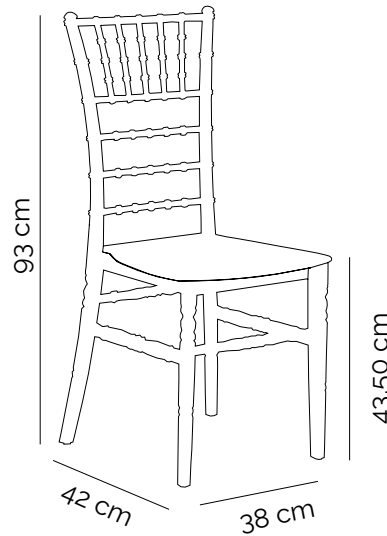

White

Net : 3,85 kg
Gross : 4,35 kg



Black & Gold & Silver

Net : 3,60 kg
Gross : 4,10 kg

200 kg max payload

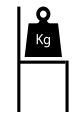

200 kg max payload

20' DC : 450 pcs

40' DC : 927 pcs

40' HC : 1133 pcs

90 cbm Truck : 1342 pcs



20' DC : 450 pcs

40' DC : 927 pcs

40' HC : 1133 pcs

90 cbm Truck : 1342 pcs

9 pcs - 41X61X235 cm - 0,58 cbm / 20'DC

11 pcs - 41X61X272 cm - 0,68 cbm / 40'HC

11 pcs - 41X61X272 cm - 0,68 cbm / Truck



9 pcs - 41X61X235 cm - 0,58 cbm / 20'DC

11 pcs - 41X61X272 cm - 0,68 cbm / 40'HC

11 pcs - 41X61X272 cm - 0,68 cbm / Truck



EN 581-1:2006
EN 1728:2000
EN 1022:2005





Ivory White
101020643



Silver
101020343



Gold
101020344



Black
101020345

Chair Tiffany PC



The polycarbonate material and the production technique adopted gas injection moulding, made it possible to create a lightweight but sturdy monoblock chair that is easily washable. Stackable up to 11 pcs which let you more space in your wedding halls, organisation areas or hotel ball saloon. Tiffany is incredibly durable, flexible and suitable for both indoor and outdoor use.

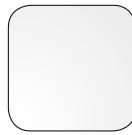

Transparent
101020720

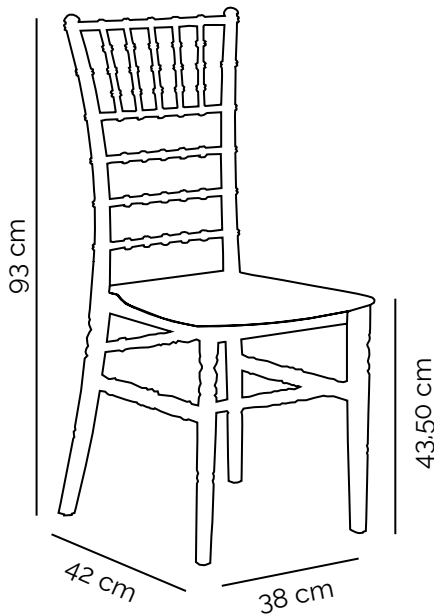

Net : 5,20 kg
Gross : 5,70 kg



200 kg max payload



20' DC : 450 pcs
40' DC : 927 pcs
40' HC : 1133 pcs
90 cbm Truck : 1342 pcs



9 pcs - 41X61X235 cm - 0,58 cbm / 20'DC
11 pcs - 41X61X272 cm - 0,68 cbm / 40'HC
11 pcs - 41X61X272 cm - 0,68 cbm / Truck

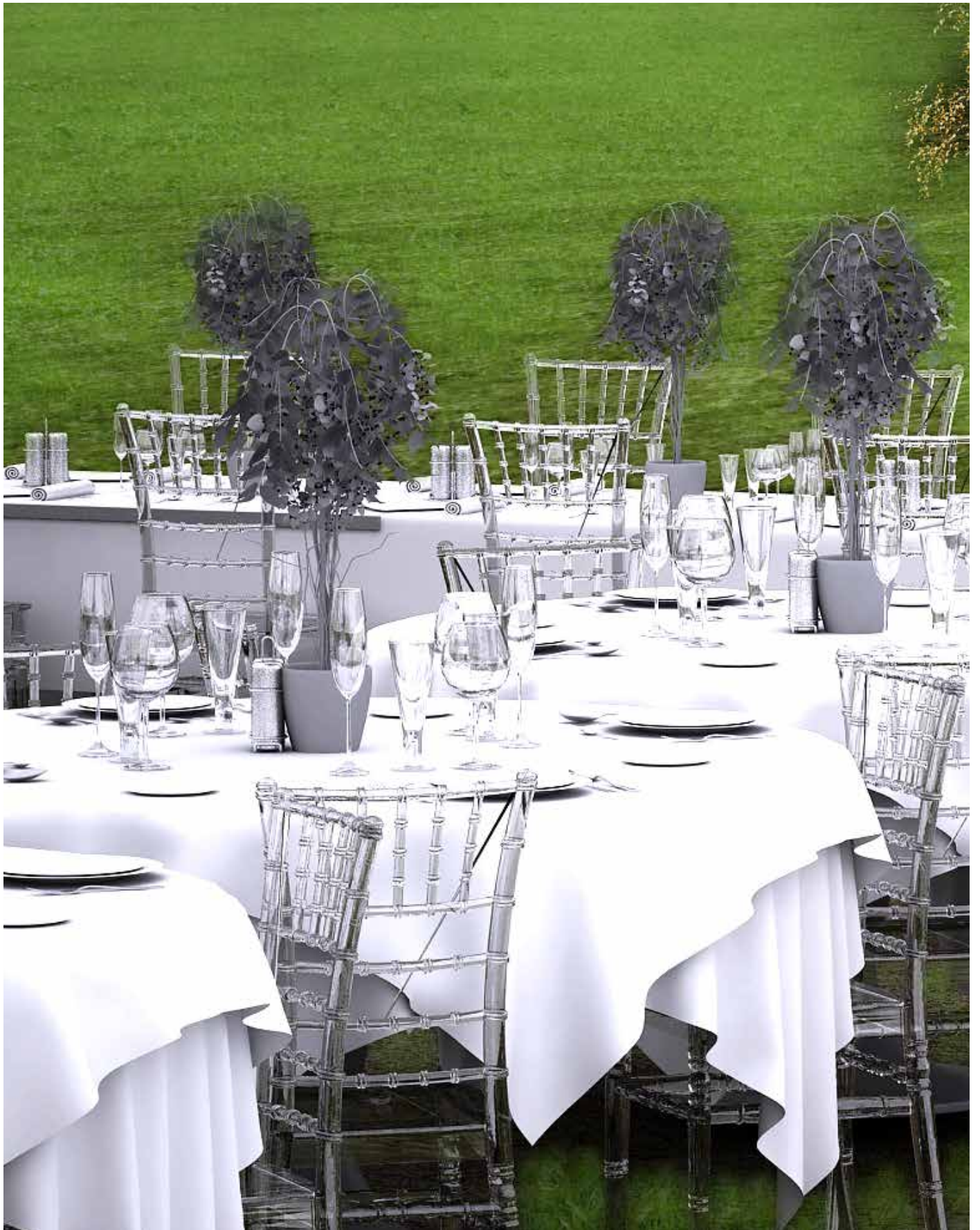

Chair Napoleon



Napoleon chair is made of monoblock polypropylene with gas assisted injection technology. You can furnish your space with the contemporary and fabulous Napoleon chair. It can be used both outdoors and indoors. Simple to stack up to 10 pieces. It is available in white and black colours.

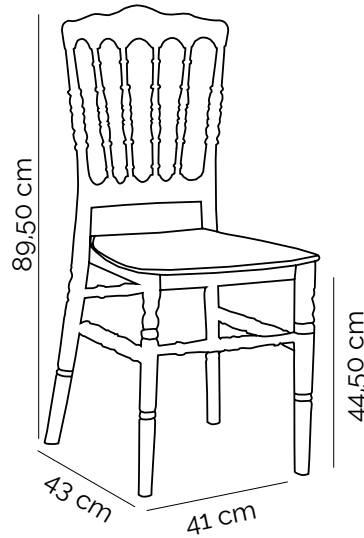

White

Net : 3,80kg
Gross : 4,30 kg



Black

Net : 3,80kg
Gross : 4,30 kg

200 kg max payload



200 kg max payload

20' DC : 424 pcs

40' DC : 864pcs

40' HC : 1080 pcs

90 cbm Truck : 1300pcs



20' DC : 424 pcs

40' DC : 864pcs

40' HC : 1080 pcs

90 cbm Truck : 1300pcs

8 pcs - 41X61X231 cm - 0,58 cbm / 20'DC

10 pcs - 41X61X268 cm - 0,67 cbm / 40'HC

10 pcs - 41X61X268 cm - 0,67 cbm / Truck



8 pcs - 41X61X231 cm - 0,58 cbm / 20'DC

10 pcs - 41X61X268 cm - 0,67 cbm / 40'HC

10 pcs - 41X61X268 cm - 0,67 cbm / Truck



EN 581-1:2006
EN 1728:2000
EN 1022:2005





Ivory White
101020644



Black
101020359

Chair Napoleon XL PP



Napoleon XL chair is made of monoblock polypropylene with gas assisted injection technology. You can furnish your space with the contemporary and fabulous Napoleon XL chair. It can be used both outdoors and indoors. Simple to stack up to 11 pieces. It is available in ivory white, gold, silver and black colours.

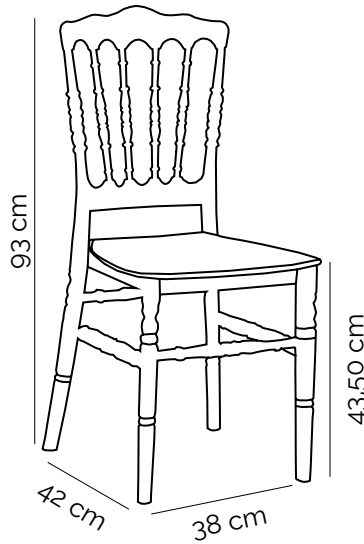

White

Net : 3,85 kg
Gross : 4,35 kg



200 kg max payload

20' DC : 450 pcs
40' DC : 927 pcs
40' HC : 1133 pcs

90 cbm Truck : 1342 pcs

9 pcs - 41X61X235 cm - 0,58 cbm / 20'DC
11 pcs - 41X61X272 cm - 0,68 cbm / 40'HC
11 pcs - 41X61X272 cm - 0,68 cbm / Truck

Black

Net : 3,60 kg
Gross : 4,10 kg



200 kg max payload

20' DC : 450 pcs
40' DC : 927 pcs
40' HC : 1133 pcs

90 cbm Truck : 1342 pcs

9 pcs - 41X61X235 cm - 0,58 cbm / 20'DC
11 pcs - 41X61X272 cm - 0,68 cbm / 40'HC
11 pcs - 41X61X272 cm - 0,68 cbm / Truck





Ivory White
101020714



Black
101020715

Chair Napoleon XL PC



The polycarbonate material and the production technique adopted gas injection moulding, made it possible to create a light weight but sturdy monoblock chair that is easily washable. Stackable up to 11 pcs which let you more space in your wedding halls, organisation areas or hotel ball saloon. Napoleon XL is incredibly durable, flexible and suitable for both indoor and outdoor use.

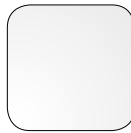

Transparent
101020719

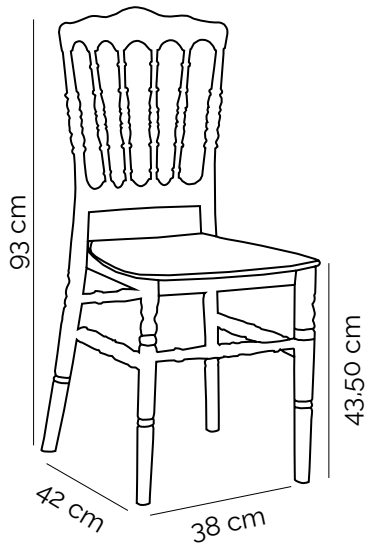

Net : 5,17 kg
Gross : 5,67 kg



200 kg max payload



20' DC : 450 pcs
40' DC : 927 pcs
40' HC : 1133 pcs
90 cbm Truck : 1342 pcs



9 pcs - 41X61X235 cm - 0,58 cbm / 20'DC
11 pcs - 41X61X272 cm - 0,68 cbm / 40'HC
11 pcs - 41X61X272 cm - 0,68 cbm / Truck



Cushion Uno



Cushion UNO is useful for Tiffany and Napoleon. You will be able to choose 3 different fabric choices. It is easy to attach and remove with velcro strips.

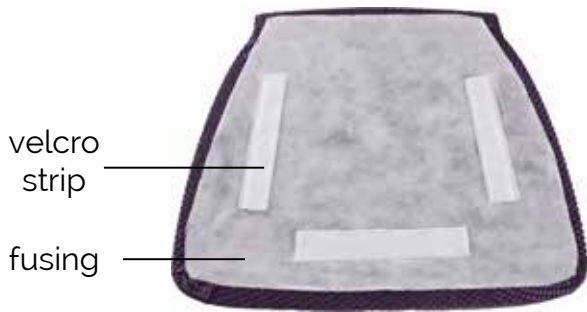

velcro strip

fusing

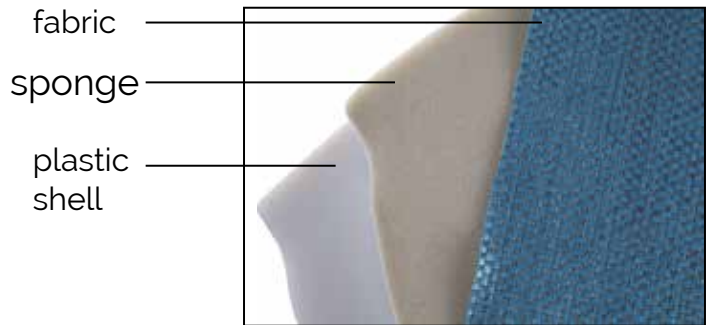

fabric

sponge

plastic shell

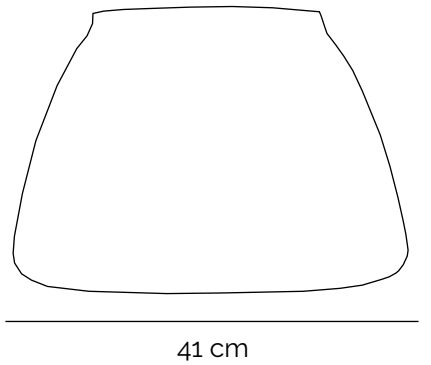

41 cm

39 cm

- Plastic shell
- Fusing
- 3 cm 28-HD grey sponge
- Mounted to seat with velcro strip
- Fabric Options : Akron, waterproof and artificial leather



Side View



Front View



Rear View

Cushion Due



Cushion DUE is useful for Tiffany and Napoleon. You will be able to choose 3 different fabric choices. It is easy to attach and remove with velcro strips. You may change the fabric by using zip.

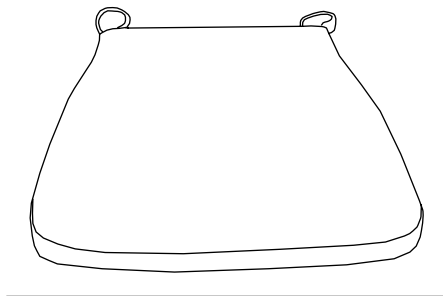

41 cm

39 cm

- 3 cm 28-HD grey sponge
- Zipper
- Mounted to back with velcro strip
- Fabric Options : Akron, waterproof and artificial leather



Side View



Front View



Rear View

Cushion Tre



Cushion TRE is useful for Tiffany and Napoleon. You will be able to choose 3 different fabric choices. It is easy to attach and remove with ropes. You may change the fabric by using zip.

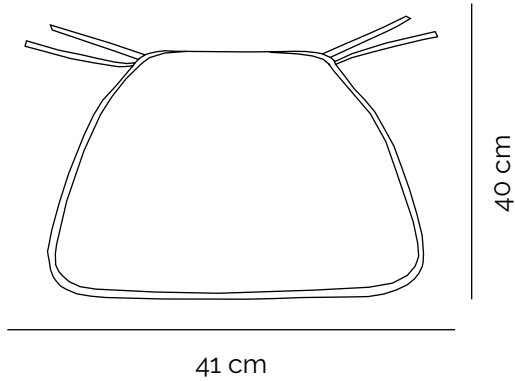

- 3 cm 28-HD grey sponge
- Zipper
- Mounted to back with ropes
- Fabric Options : Akron, waterproof and artificial leather



Side View



Front View



Rear View

Akron Fabric Options (Indoor)



Akron
59



Akron
101

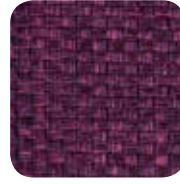

Akron
55



Akron
43



Akron
01



Akron
32



Akron
10



Akron
42



Akron
28



Akron
37

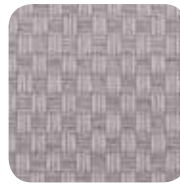

Akron
05

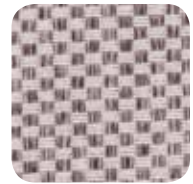

Akron
35



Akron
34

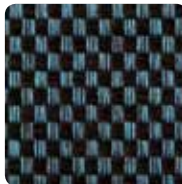

Akron
44



Akron
36



Akron
30

Akron Fabric (indoor use)

70 % Olefin + 30 % Polyester

Test ISO 12945-2 (Pilling)
ISO 13936-2 (Seam Slippage)
ISO 12947-2 (Abrasion)
ISO 105x12 (Rubbing)



hand
wash

Waterproof Fabric Options (Outdoor)



WR
01



WR
02



WR
03



WR
04



WR
05



WR
06



WR
07



WR
08



WR
09



WR
10



WR
11



WR
12

Waterproof Fabric (outdoor use)

% 100 Polyester

PU waterproof layer

- It should be wiped gently and circular with a damp cloth



hand
wash

Artificial Leather Fabric Options (Outdoor)

Plain



PU
01



PU
02



PU
03



PU
04

Wicker



PU
05



PU
06



PU
07



PU
08

Diamond



PU
09



PU
10



PU
11



PU
12

Artificial Leather Fabric (outdoor use)

- Nature and human friendly products can be produced by without using toxic chemicals which harm human health.
- To remove oil stains; use a soapy cotton cloth and gently rub the stain with circular movements. After that use a clean, humid cloth to wipe off the area and dry the surface.
- To remove dust; use a vacuum cleaner or a soft brush.



hand
wash



Savaş Plastik A.Ş.

Beysan Sanayi Sitesi Birlik Caddesi No:18

34524 Beylikdüzü, İstanbul, Türkiye

+ 90 850 346 65 65

+ 90 212 422 34 06

+ 90 212 422 46 25

 www.tilia.com.tr

 /tiliafurniture

 /TiliaFurniture

 info@tilia.com.tr

 /tiliaContract

 /TiliaFurniture

www.tilia.com.tr

