



ASSEMBLY SCHEMA

Gora N

(Wooden Leg)

Contents

a) 1 pc. Seat

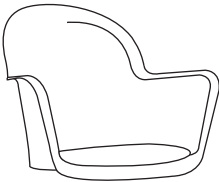

b) 1 pc. Armchair Leg

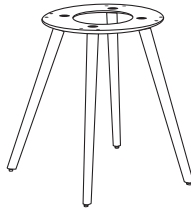

c) 8 pcs. Screw



1

Place the seat (a) upside down on a suitable ground, and place the chair leg (b) below the seat with the arrow direction pointing the front of the seat.

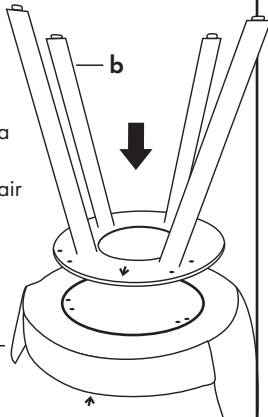

2

Ensure the direction is correct, then fix the chair leg (c) with screws (c) with a suitable hand tool.

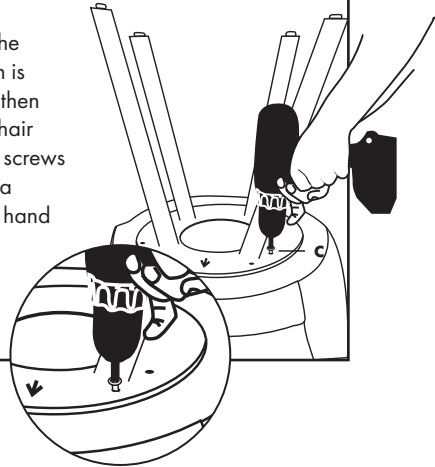

Please be sure not to miss any screw holes and fasten all screws equally and tightly. Otherwise, you may face breakage or cracking during the time of usage.

Tilia

KURULUM ŞEMASI

Gora N

(Ahşap Ayak)

İçerik

a) 1 ad. Kabuk

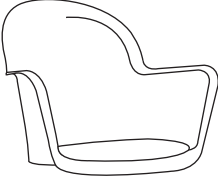

b) 1 ad. Sandalye Ayağı

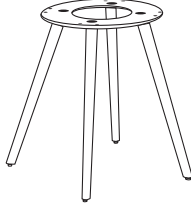

c) 8 ad. Vida



1

Kabuğu(a) uygun bir zemine ters olarak yerleştirin ve ayağı(b) ok yönü koltuğun gelecek şekilde kabuk üzerine oturtun.

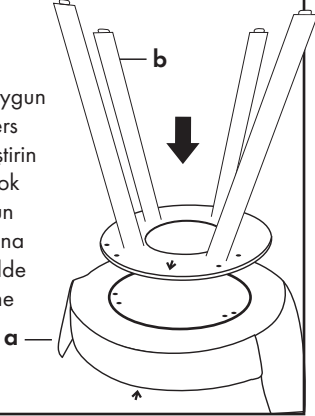

2

Yönünden emin olduğunuz ayağı 8 adet vidayla(c) uygun el aleti yardımıyla (matkap/ tornavida) sabitleyin.

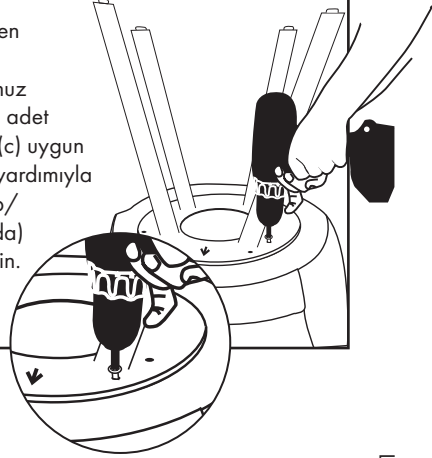

Lütfen montajınızı yaparken vida deliklerini atlamamaya, vidaların tam ve sıkı olduğuna emin olunuz. Aksi halde ürünün kullanımı sırasında kırılma/çatlama ile karşılaşabilirsiniz.

V08032021